

## Lms13LED



Device parameters	Symbol	Value	Units
Operating/ storage temperature	$T_{stg}$	+5..+90*	$^{\circ}\text{C}$
Soldering temperature (can be applied for not more than 5 secs)	$T_{sol}$	+180	$^{\circ}\text{C}$

\*LED design for different storage/operating temperature range can be considered under request.

All parameters are for LED operation at 25 $^{\circ}\text{C}$  unless otherwise stated.

LED parameters	Conditions	Symbol	Value	Units
Peak emission wavelength <sup>1</sup>	qCW mode <sup>3</sup> I = 25 mA	$\lambda_p$	1.25 - 1.33	$\mu\text{m}$
FWHM of the emission band <sup>1</sup>	qCW mode <sup>3</sup> I = 25 mA	FWHM	70 - 100	nm
Average optical power (minimal / typical) <sup>1</sup>	qCW mode <sup>3</sup> I = 200 mA	$P_{qCW}$	min 10 / typ 12	mW
Peak optical power (minimal / typical) <sup>2</sup>	Pulse mode <sup>4</sup> I = 1 A	$P_{pul}$	min 25 / typ 29	mW
Maximum operating current	qCW mode <sup>3</sup>	$I_{qCW}$	200	mA
	Pulse mode <sup>4</sup>	$I_{pul}$	1	A
	DC mode <sup>5</sup>	$I_{DC}$	100	mA
Forward voltage <sup>1</sup>	qCW mode <sup>3</sup> I = 200 mA	V	0.9 - 1.2	V

Typical spectrum (qCW<sup>3</sup>, 25 mA)

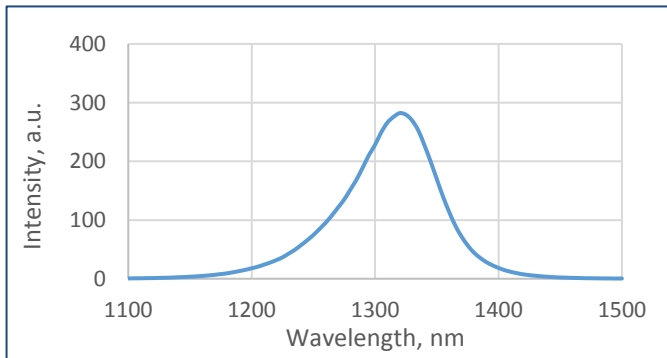

Spectra at different temperatures (qCW<sup>3</sup>, 25 mA)

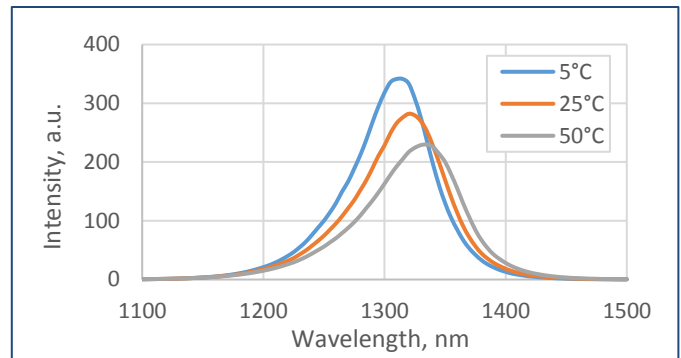

Typical optical power characteristic (qCW<sup>3</sup>)

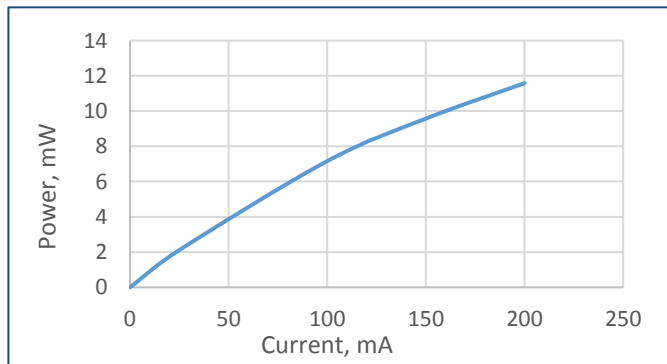

Typical current-voltage characteristic (qCW<sup>3</sup>)

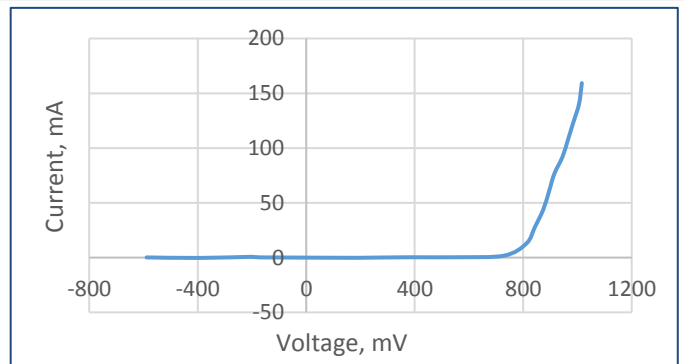

<sup>1</sup> Parameter tested for each device.

<sup>2</sup> Parameter tested for representative sampling.

<sup>3</sup> qCW mode: repetition rate: 0.5 KHz, pulse duration: 1 ms, duty cycle: 50%.

<sup>4</sup> Pulse mode: repetition rate: 0.5 KHz, pulse duration: 20  $\mu\text{s}$ , duty cycle: 1%.

<sup>5</sup> DC mode: direct current.

Packages	Model
TO-18 with a cap with a glass window	Lms13LED
TO-18 with a parabolic reflector without a glass window	Lms13LED-R
TO-18 with a parabolic reflector with a glass window	Lms13LED-RW
TO-5 with a built-in thermocooler and thermoresistor, covered by a cap with a glass window	Lms13LED-TEM
TO-5 with a built-in thermocooler and thermoresistor, covered by a parabolic reflector with a glass window	Lms13LED-TEM-R

### Radiant characteristic (far-field pattern)

TO-18 package with a cap

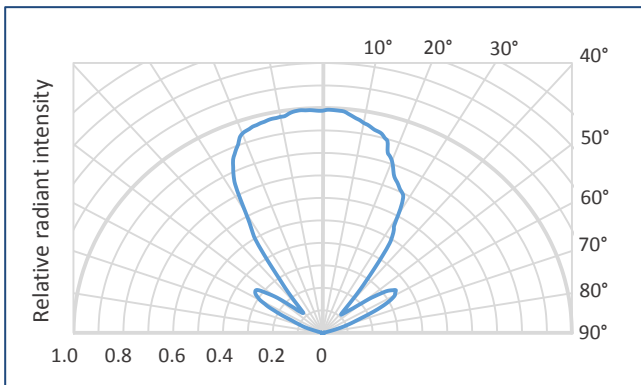

### Related products:

- **Photodiodes Lms24PD, Lms25PD series** - detectors of mid-infrared radiation;
- **LED drivers (D-41i, D-51i, minidrivers mD-1c, mD-1p)** - provide LED power supply in pulse modes.

To drive the LED we recommend the following basic circuit connection:

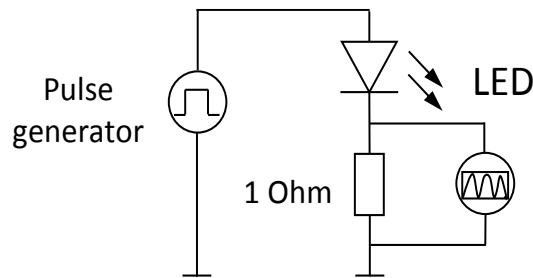

We recommend using **Quasi Continuous Wave (qCW) mode** with a duty cycle 50% or 25% to obtain maximum average optical power and short **Pulse modes** to obtain maximum peak power.

### Quasi Continuous Wave (qCW) mode

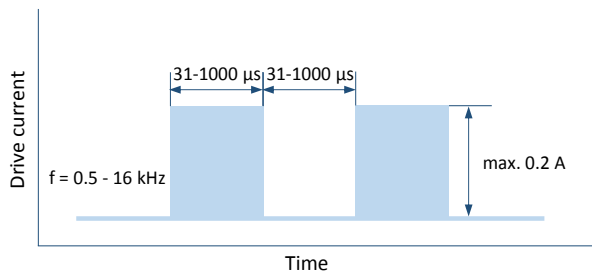

### Pulse mode

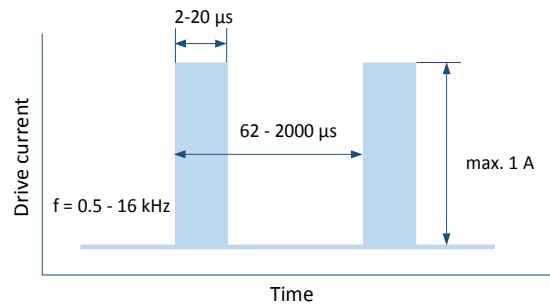

### IMPORTANT CAUTIONS:

- please check your connection circuit before turning on the LED;
- please mind the LED polarity: anode is marked with a RED dot; REVERSE voltage applying is FORBIDDEN;
- please do not connect the LED to the multimeter;
- please control the CURRENT applied to the LED in order NOT to EXCEED the maximum allowable values.

Technical Drawing

Lms13LED

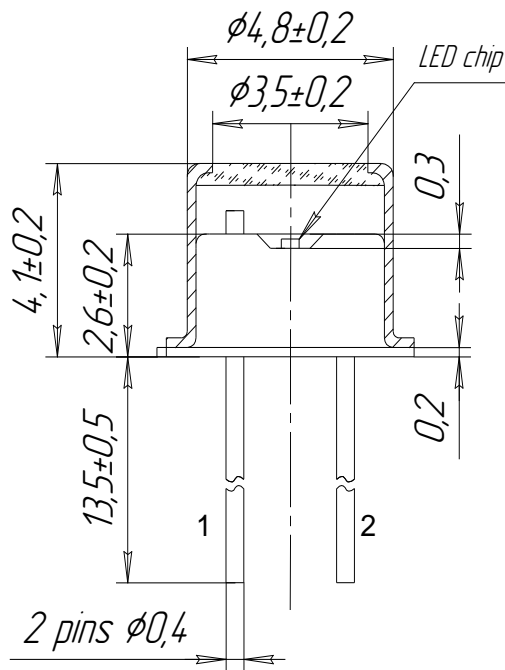

1 - LED anode  
2 - LED cathode

