

Lms15LED-RW

Device parameters	Symbol	Value	Units
Operating/ storage temperature	T_{stg}	+5..+90*	$^{\circ}\text{C}$
Soldering temperature (can be applied for not more than 5 secs)	T_{sol}	+180	$^{\circ}\text{C}$

*LED design for different storage/operating temperature range can be considered under request.

All parameters are for LED operation at 25 $^{\circ}\text{C}$ unless otherwise stated.



LED parameters	Conditions	Symbol	Value	Units
Peak emission wavelength ¹	qCW mode ³ I = 25 mA	λ_p	1.50 - 1.59	μm
FWHM of the emission band ¹	qCW mode ³ I = 25 mA	FWHM	110 - 140	nm
Average optical power (minimal / typical) ¹	qCW mode ³ I = 200 mA	P_{qCW}	min 7 / typ 10	mW
Peak optical power (minimal / typical) ²	Pulse mode ⁴ I = 1 A	P_{pul}	min 20 / typ 26	mW
Maximum operating current	qCW mode ³	I_{qCW}	200	mA
	Pulse mode ⁴	I_{pul}	1	A
	DC mode ⁵	I_{DC}	100	mA
Forward voltage ¹	qCW mode ³ I = 200 mA	V	0.8 - 1.1	V

Typical spectrum (qCW³, 25 mA)

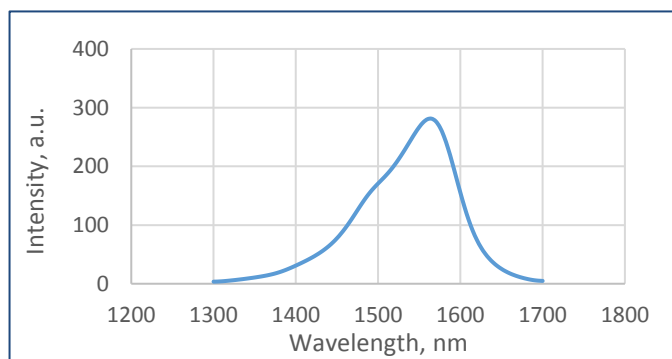

Spectra at different temperatures (qCW³, 25 mA)

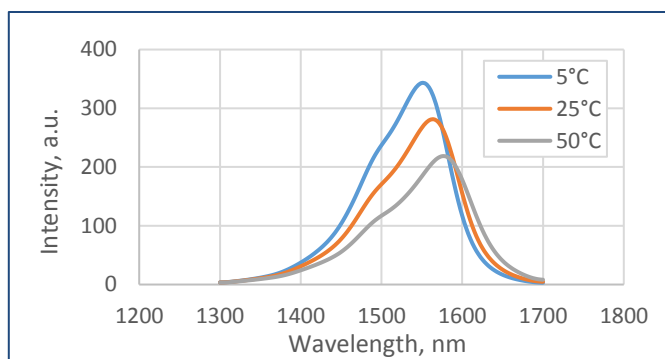

Typical optical power characteristic (qCW³)

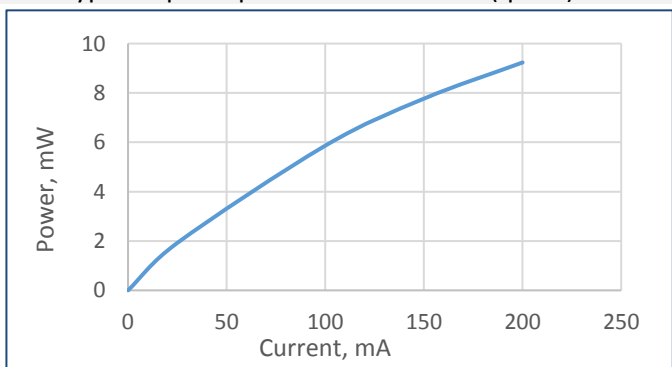

Typical current-voltage characteristic (qCW³)

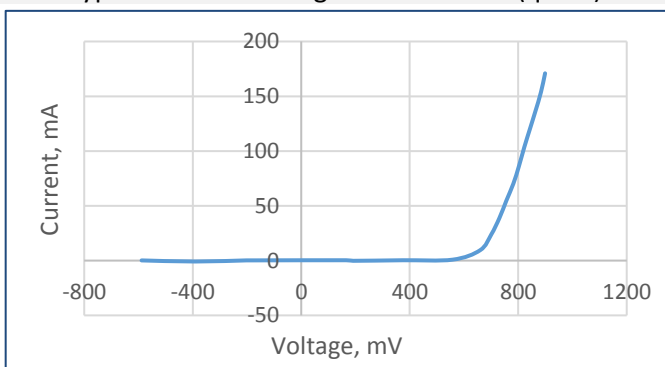

¹ Parameter tested for each device.

² Parameter tested for representative sampling.

³ qCW mode: repetition rate: 0.5 KHz, pulse duration: 1 ms, duty cycle: 50%.

⁴ Pulse mode: repetition rate: 0.5 KHz, pulse duration: 20 μs , duty cycle: 1%.

⁵ DC mode: direct current.

Packages	Model
TO-18 with a cap with a glass window	Lms15LED
TO-18 with a parabolic reflector without a glass window	Lms15LED-R
TO-18 with a parabolic reflector with a glass window	Lms15LED-RW
TO-5 with a built-in thermocooler and thermoresistor, covered by a cap with a glass window	Lms15LED-TEM
TO-5 with a built-in thermocooler and thermoresistor, covered by a parabolic reflector with a glass window	Lms15LED-TEM-R

Radiant characteristic (far-field pattern)

TO-18 package with a parabolic reflector

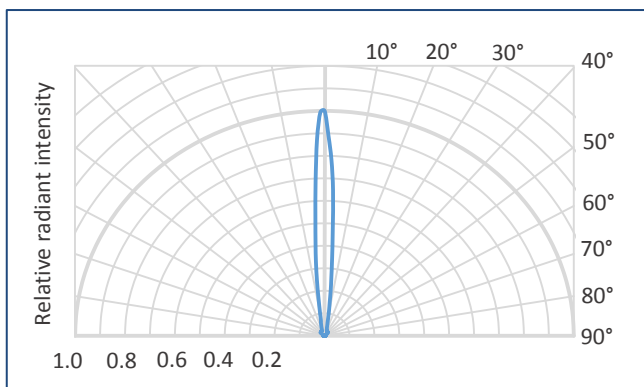

Related products:

- **Photodiodes Lms24PD, Lms25PD series** - detectors of mid-infrared radiation;
- **LED drivers (D-41i, D-51i, minidrivers mD-1c, mD-1p)** - provide LED power supply in pulse modes.

To drive the LED we recommend the following basic circuit connection:

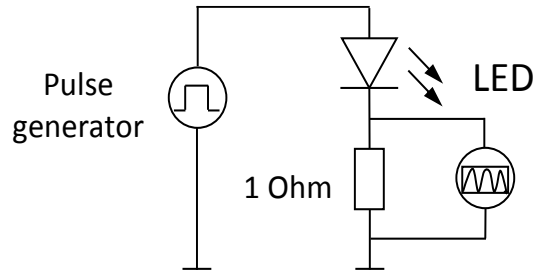

We recommend using **Quasi Continuous Wave (qCW) mode** with a duty cycle 50% or 25% to obtain maximum average optical power and short **Pulse modes** to obtain maximum peak power.

Quasi Continuous Wave (qCW) mode

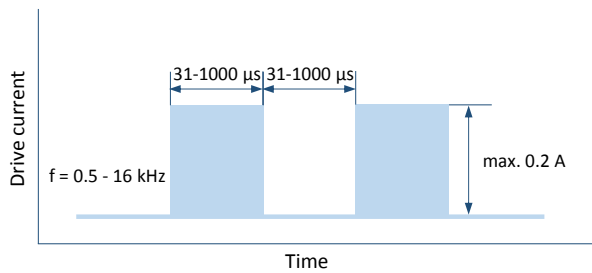

Pulse mode

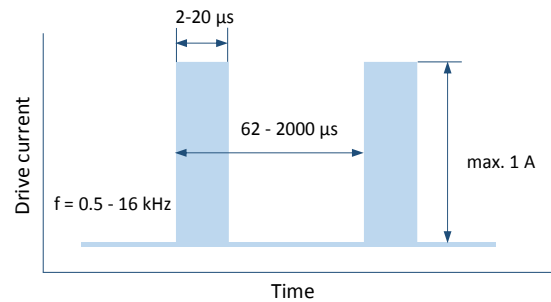

IMPORTANT CAUTIONS:

- please check your connection circuit before turning on the LED;
- please mind the LED polarity: anode is marked with a RED dot; REVERSE voltage applying is FORBIDDEN;
- please do not connect the LED to the multimeter;
- please control the CURRENT applied to the LED in order NOT to EXCEED the maximum allowable values.

Technical Drawing

Lms15LED-RW

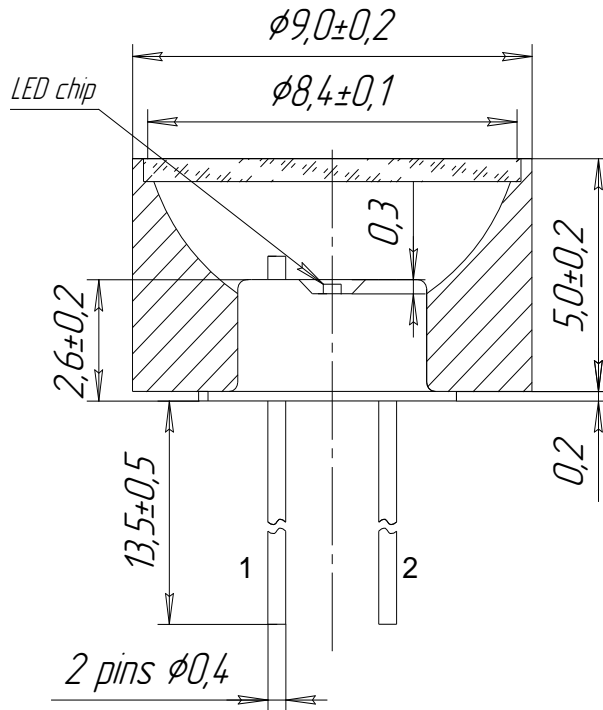

1 - LED anode
2 - LED cathode

TOP VIEW

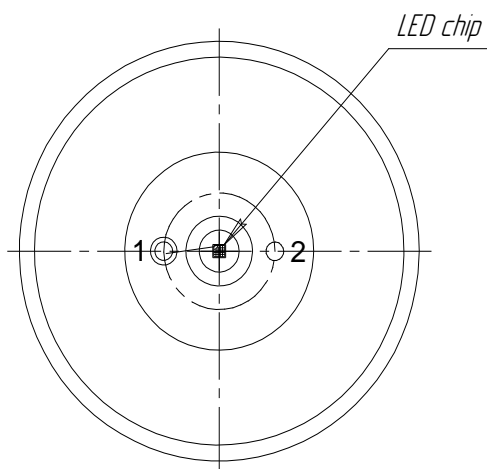

BOTTOM VIEW

