

## Lms35LED



| Device parameters  | Symbol    | Value     | Units              |
|--|-----------|-----------|--------------------|
| Operating/ storage temperature                                     | $T_{stg}$ | -60..+90* | $^{\circ}\text{C}$ |
| Soldering temperature<br>(can be applied for not more than 5 secs) | $T_{sol}$ | +180      | $^{\circ}\text{C}$ |

\*LED design for different storage/operating temperature range can be considered under request.

All parameters are for LED operation at 25 $^{\circ}\text{C}$  unless otherwise stated.

| LED parameters   | Conditions                       | Symbol           | Value             | Units         |
|--|----------------------------------|------------------|-------------------|---------------|
| Peak emission wavelength <sup>1</sup>                  | qCW mode <sup>3</sup> I = 150 mA | $\lambda_p$      | 3.45 - 3.52       | $\mu\text{m}$ |
| FWHM of the emission band <sup>1</sup>                 | qCW mode <sup>3</sup> I = 150 mA | FWHM             | 300 - 600         | nm            |
| Average optical power (minimal / typical) <sup>1</sup> | qCW mode <sup>3</sup> I = 200 mA | $P_{qCW}$        | min 20 / typ 40   | $\mu\text{W}$ |
| Peak optical power (minimal / typical) <sup>2</sup>    | Pulse mode <sup>4</sup> I = 1 A  | $P_{pul}$        | min 150 / typ 300 | $\mu\text{W}$ |
| Maximum operating current                              | qCW mode <sup>3</sup>            | $I_{max\ qCW}$   | 250               | mA            |
|  | Pulse mode <sup>4</sup>          | $I_{max\ pulse}$ | 2                 | A             |
| Forward voltage <sup>1</sup>                           | qCW mode <sup>3</sup> I = 200 mA | V                | 0.2 - 0.8         | V             |

Typical spectra at different currents (qCW<sup>3</sup>)

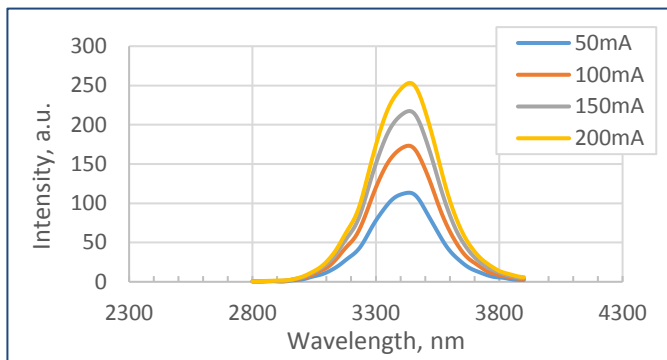

Spectra at different temperatures (qCW<sup>3</sup>, 150 mA)

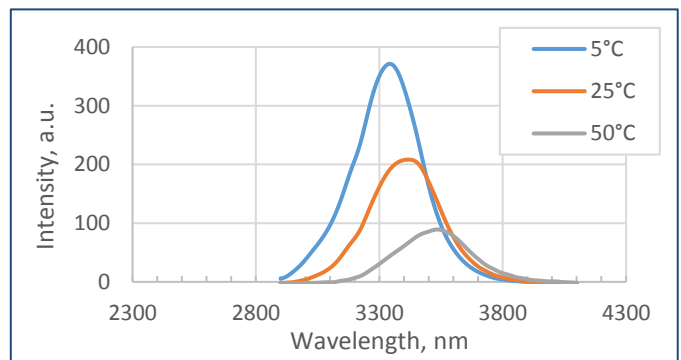

Typical optical power characteristic (qCW<sup>3</sup>)

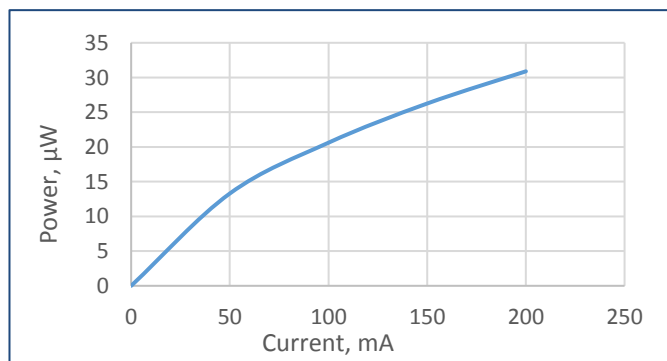

Typical current-voltage characteristic (qCW<sup>3</sup>)

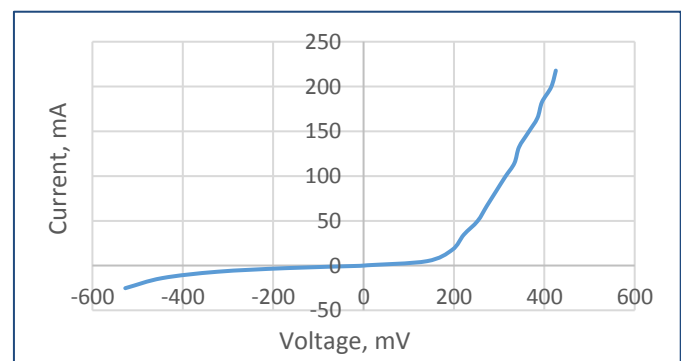

<sup>1</sup> Parameter tested for each device.

<sup>2</sup> Parameter tested for representative sampling.

<sup>3</sup> qCW mode: repetition rate: 0.5 KHz, pulse duration: 1 ms, duty cycle: 50%.

<sup>4</sup> Pulse mode: repetition rate: 0.5 KHz, pulse duration: 20  $\mu\text{s}$ , duty cycle: 1%.

| Packages   | Model          |
|--|----------------|
| TO-18 with a cap without a glass window  | Lms35LED       |
| TO-18 with a parabolic reflector without a glass window  | Lms35LED-R     |
| TO-18 with a parabolic reflector with a glass window   | Lms35LED-RW    |
| TO-5 with a built-in thermocooler and thermoresistor, covered by a cap with a glass window                 | Lms35LED-TEM   |
| TO-5 with a built-in thermocooler and thermoresistor, covered by a parabolic reflector with a glass window | Lms35LED-TEM-R |

### Radiant characteristic (far-field pattern)

TO-18 package with a cap

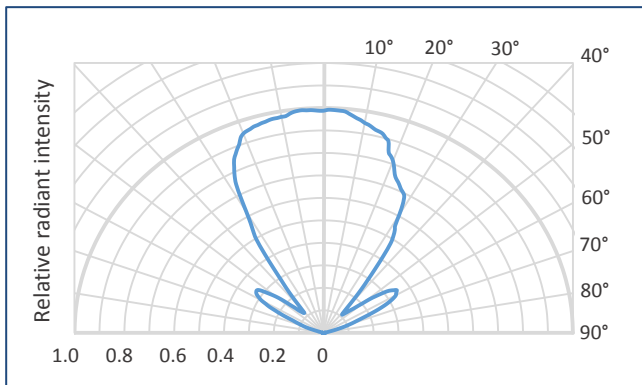

### Related products:

- **Photodiodes Lms36PD, Lms41PD series** - detectors of mid-infrared radiation;
- **LED drivers (D-41i, D-51i, minidrivers mD-1c, mD-1p )** - provide LED power supply in pulse modes.

To drive the LED we recommend the following basic circuit connection:

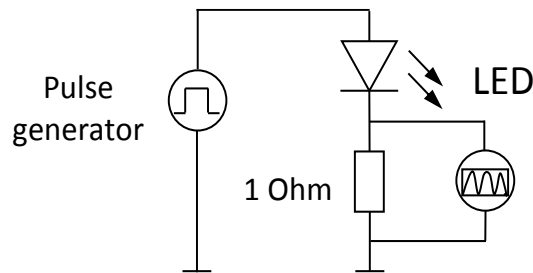

We recommend using **Quasi Continuous Wave (qCW) mode** with a duty cycle 50% or 25% to obtain maximum average optical power and short **Pulse modes** to obtain maximum peak power. Hard CW (continuous wave) mode is NOT recommended.

### Quasi Continuous Wave (qCW) mode

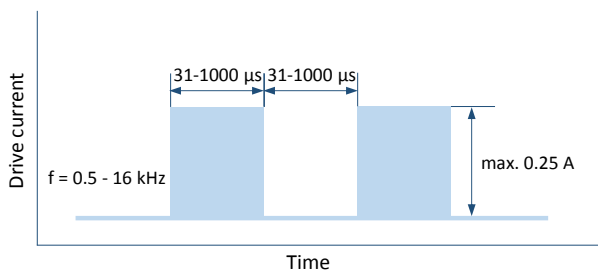

### Pulse mode

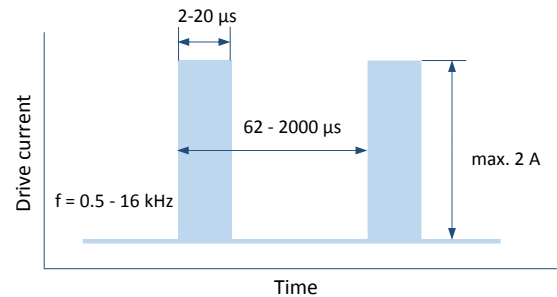

### IMPORTANT CAUTIONS:

- please check your connection circuit before turning on the LED;
- please mind the LED polarity: anode is marked with a RED dot; REVERSE voltage applying is FORBIDDEN;
- please do not connect the LED to the multimeter;
- please control the CURRENT applied to the LED in order NOT to EXCEED the maximum allowable values.

Technical Drawing

Lms35LED

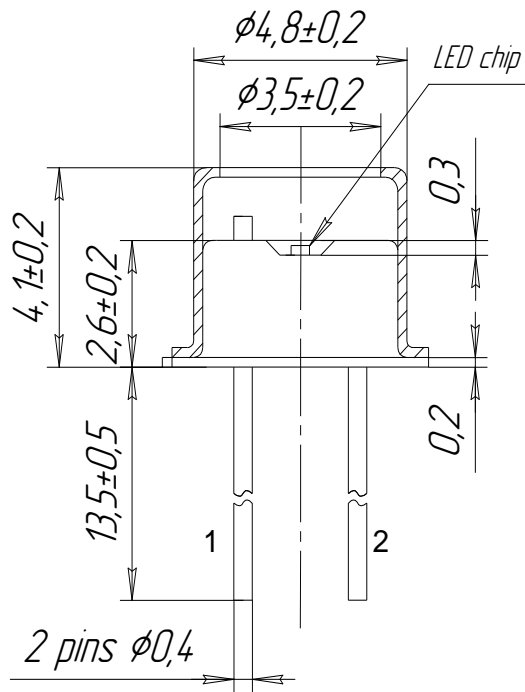

1 - LED cathode  
2 - LED anode

TOP VIEW

BOTTOM VIEW

