

## Lms36LED-TEM



Device parameters	Symbol	Value	Units
Operating/ storage temperature	$T_{stg}$	+5..+90*	$^{\circ}\text{C}$
Soldering temperature (can be applied for not more than 5 secs)	$T_{sol}$	+180	$^{\circ}\text{C}$

\*LED design for different storage/operating temperature range can be considered under request.

All parameters are for LED operation at 25 $^{\circ}\text{C}$  unless otherwise stated.

LED parameters	Conditions	Symbol	Value	Units
Peak emission wavelength <sup>1</sup>	qCW mode <sup>3</sup> I = 150 mA	$\lambda_p$	3.53 - 3.69	$\mu\text{m}$
FWHM of the emission band <sup>1</sup>	qCW mode <sup>3</sup> I = 150 mA	FWHM	300 - 600	nm
Average optical power (minimal / typical) <sup>1</sup>	qCW mode <sup>3</sup> I = 200 mA	$P_{qcw}$	min 11 / typ 28	$\mu\text{W}$
Peak optical power (minimal / typical) <sup>2</sup>	Pulse mode <sup>4</sup> I = 1 A	$P_{pul}$	min 84 / typ 210	$\mu\text{W}$
Maximum operating current	qCW mode <sup>3</sup>	$I_{max\ qcw}$	250	mA
	Pulse mode <sup>4</sup>	$I_{max\ pulse}$	2	A
Forward voltage <sup>1</sup>	qCW mode <sup>3</sup> I = 200 mA	V	0.2 - 0.8	V

Typical spectra at different currents (qCW<sup>3</sup>)

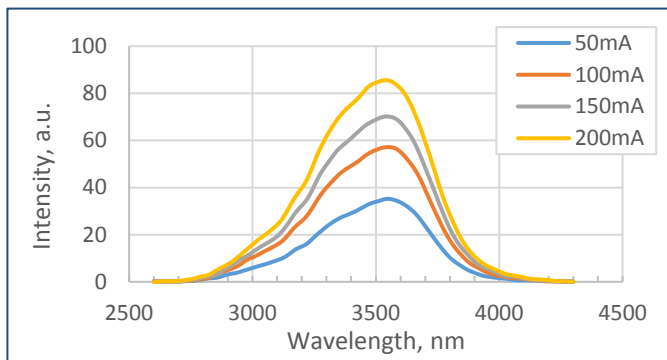

Spectra at different temperatures (qCW<sup>3</sup>, 150 mA)

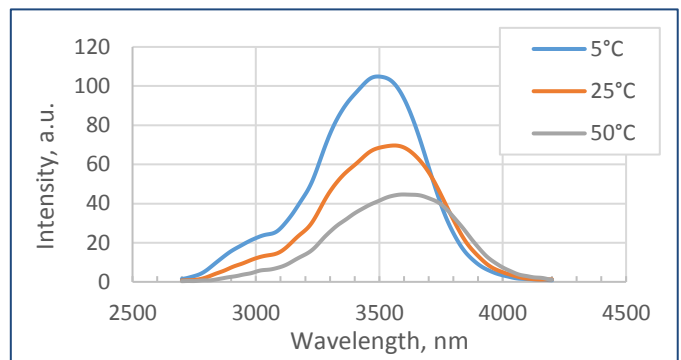

Typical optical power characteristic (qCW<sup>3</sup>)

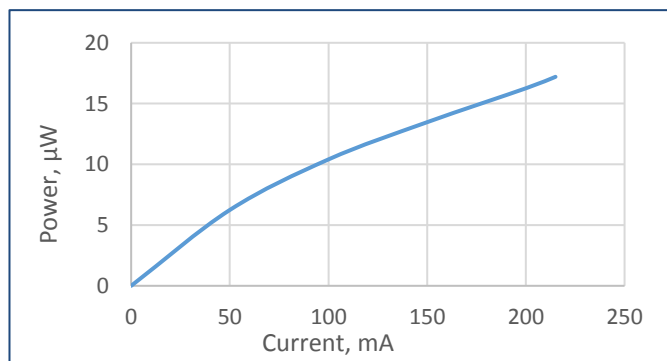

Typical current-voltage characteristic (qCW<sup>3</sup>)

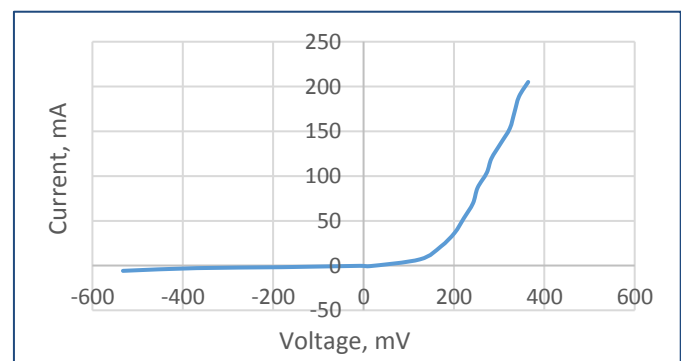

<sup>1</sup> Parameter tested for each device.

<sup>2</sup> Parameter tested for representative sampling.

<sup>3</sup> qCW mode: repetition rate: 0.5 KHz, pulse duration: 1 ms, duty cycle: 50%.

<sup>4</sup> Pulse mode: repetition rate: 0.5 KHz, pulse duration: 20  $\mu\text{s}$ , duty cycle: 1%.

Packages	Model
TO-18 with a cap without a glass window	Lms36LED
TO-18 with a parabolic reflector without a glass window	Lms36LED-R
TO-18 with a parabolic reflector with a glass window	Lms36LED-RW
TO-5 with a built-in thermocooler and thermoresistor, covered by a cap with a glass window	Lms36LED-TEM
TO-5 with a built-in thermocooler and thermoresistor, covered by a parabolic reflector with a glass window	Lms36LED-TEM-R

Related products:

- **Photodiodes Lms41PD series** - detectors of mid-infrared radiation;
- **LED drivers (D-41i, D-51i, minidrivers mD-1c, mD-1p)** - provide LED power supply in pulse modes.

To drive the LED we recommend the following basic circuit connection:

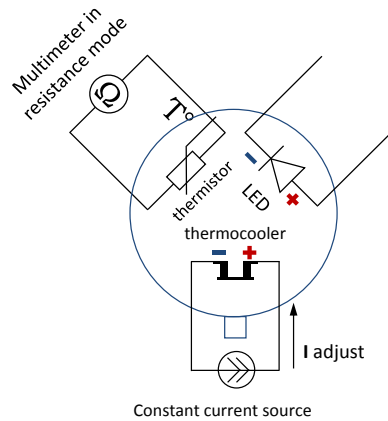

We recommend using **Quasi Continuous Wave (qCW) mode** with a duty cycle 50% or 25% to obtain maximum average optical power and short **Pulse modes** to obtain maximum peak power. Hard CW (continuous wave) mode is NOT recommended.

### Quasi Continuous Wave (qCW) mode

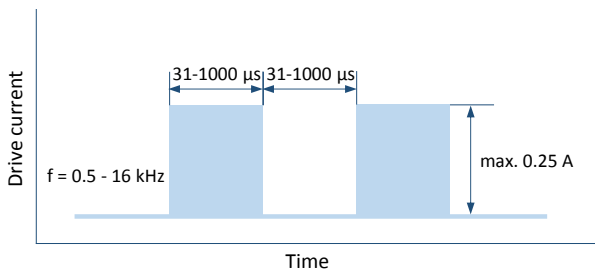

### Pulse mode

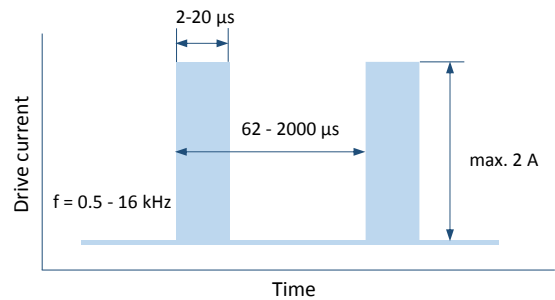

### IMPORTANT CAUTIONS:

- please check your connection circuit before turning on the LED;
- please mind the LED polarity: anode is marked with a RED dot; REVERSE voltage applying is FORBIDDEN;
- please do not connect the LED to the multimeter;
- please control the CURRENT applied to the LED in order NOT to EXCEED the maximum allowable values.

Technical Drawing

Lms36LED-TEM

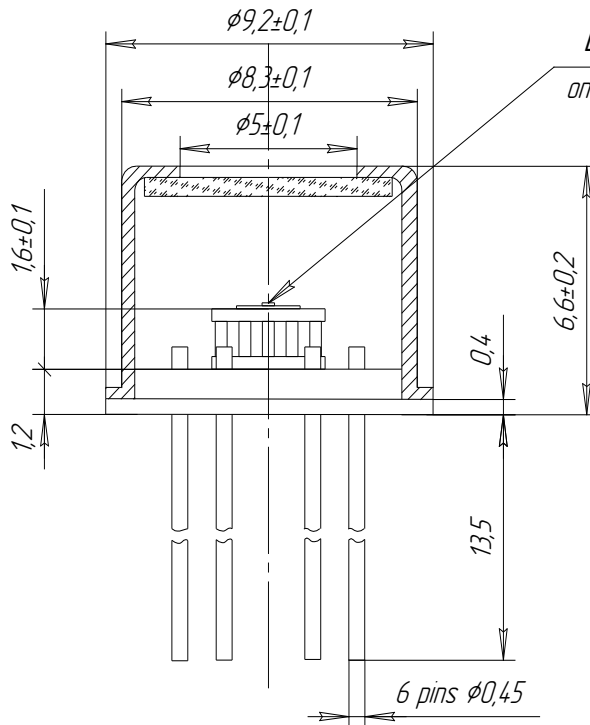

- 1 - TEC +
- 2 - LED anode
- 3 - LED cathode
- 4 - thermistor
- 5 - thermistor
- 6 - TEC -

TOP VIEW

BOTTOM VIEW

